

**NAMRON TAKARMATUR MIRA
LED 15W SENSOR**

220-240V~ 50Hz LED IP54



LED effekt:	15W	LED power:	15W
Spenning:	220-240V~,50Hz	Voltage:	220-240V~,50Hz
Lumen:	1600lm	Lumen:	1600lm
Kelvin:	2700K	Kelvin:	2700K
Lysspredning:	120°	Beam angle:	120°
CRI:	80	CRI:	80
Levetid:	25.000timer	Lifetime:	25,000hours

MONTERING/MOUNTING

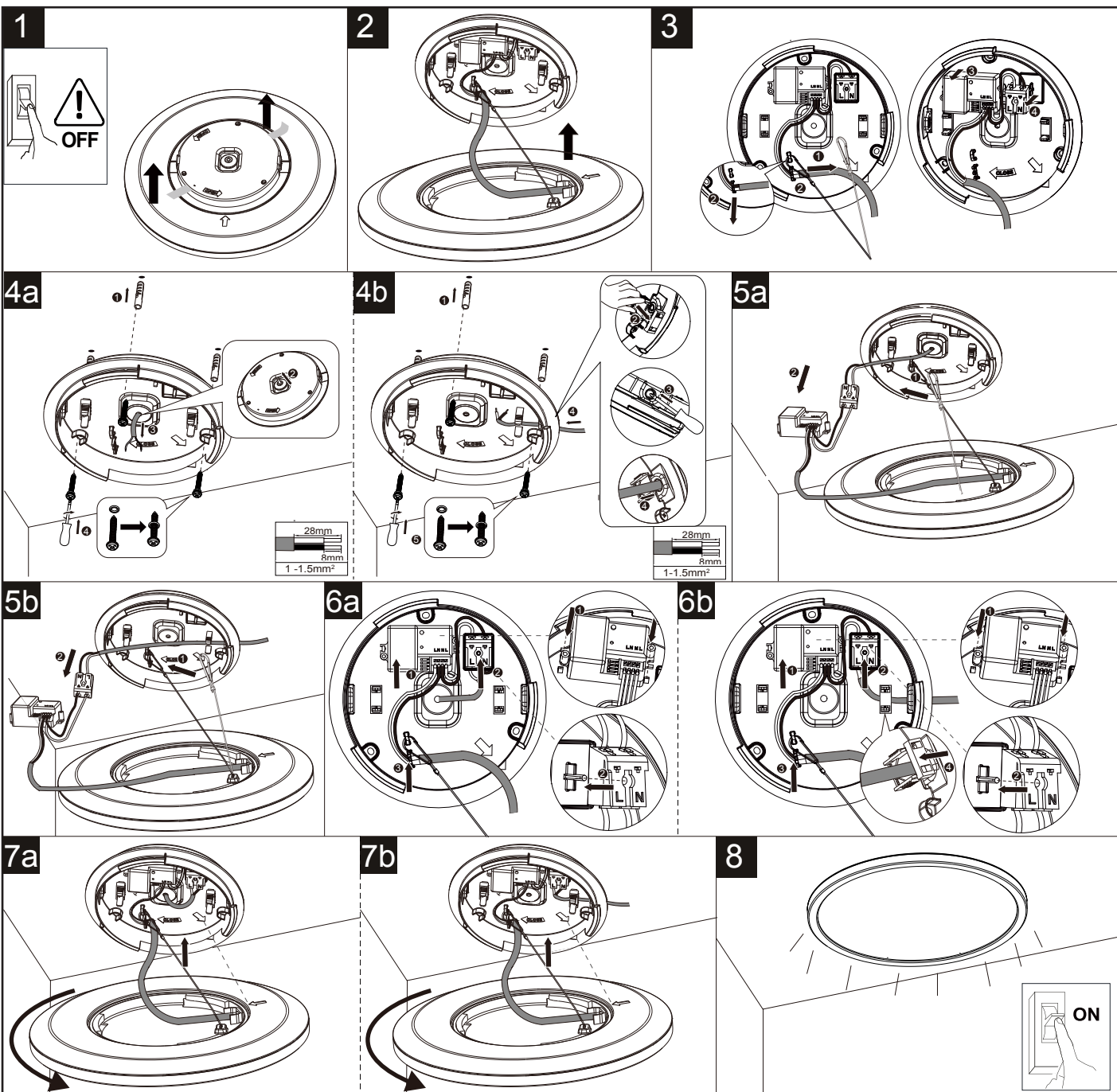

Max. number of inter-connected : 12pcs(2110476101)/15pcs(2110456101)

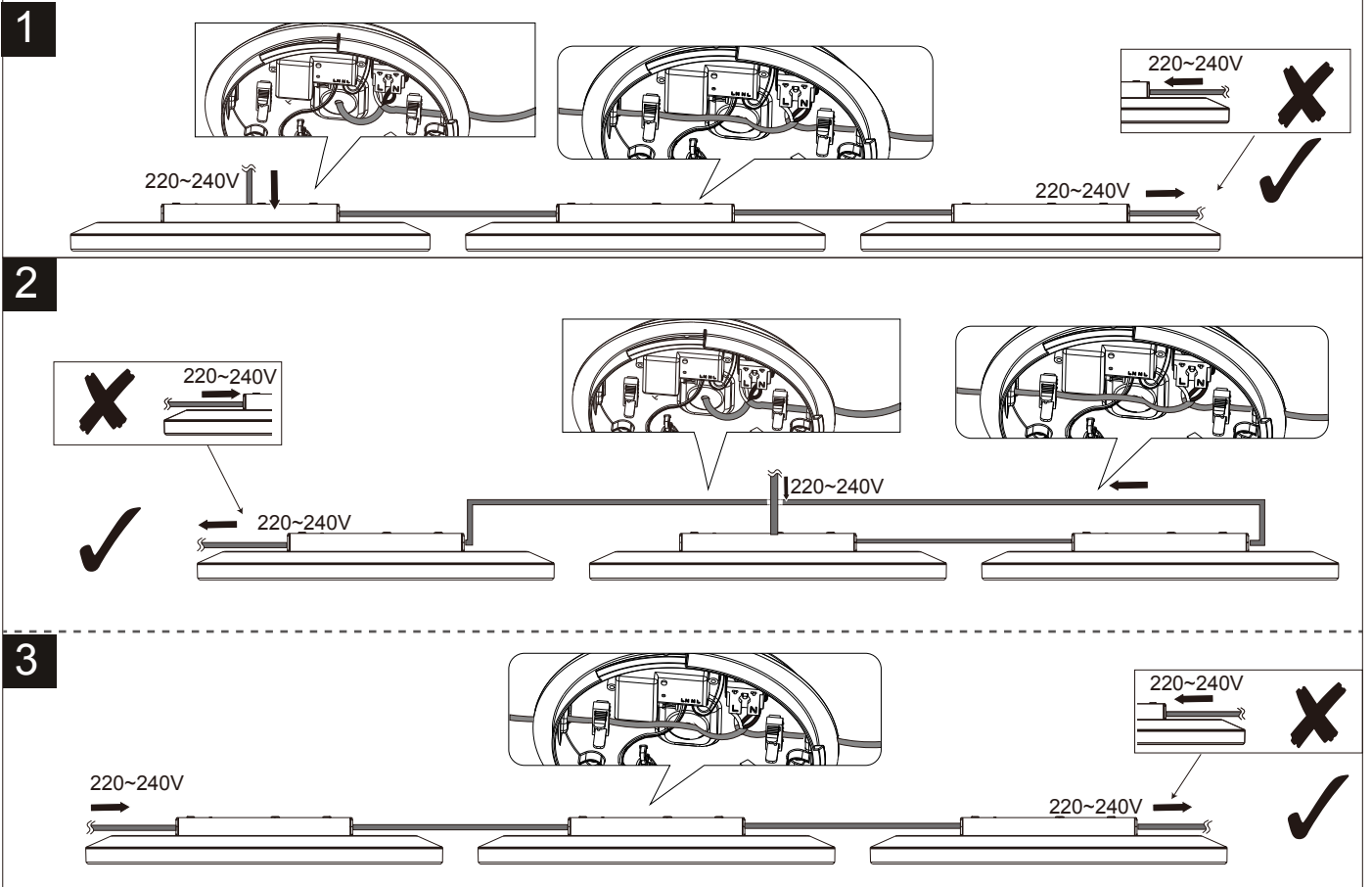

Please note that microwave sensors generate an electromagnetic (RF) field between transmitter and receiver and create an invisible volumetric detection zone. Be aware that microwave sensors are highly sensitive and can emit a signal that can even travel through glass and thin walls!

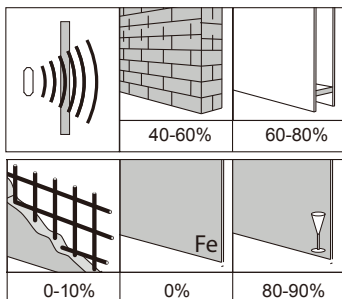

Standby power		≤ 0.5W
Microwave frequency		5.8GHz+/-75MHz
Microwave power		< 0.3mW

Sensor:

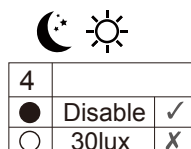
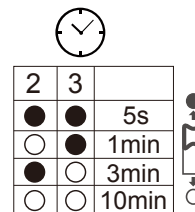
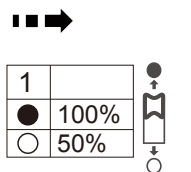
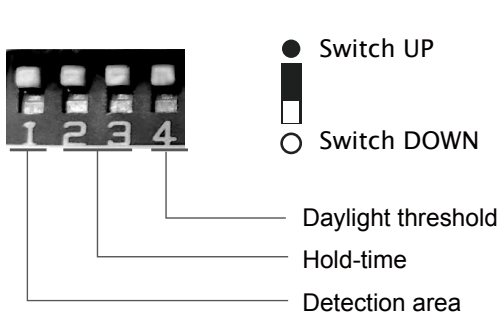
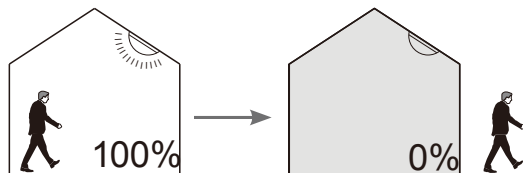

MÅL / MEASURES

