

NAMRON THERMOSTAT TOUCH ZIGBEE 16A

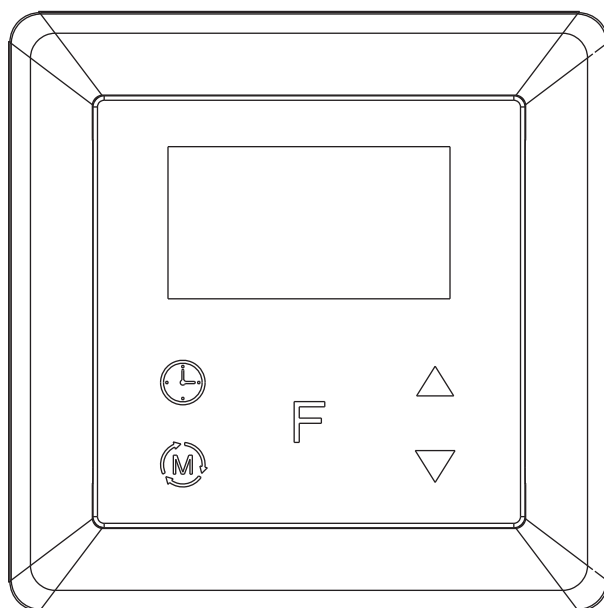

INSTRUCTION MANUAL

Namron termostat touch ZigBee 16A

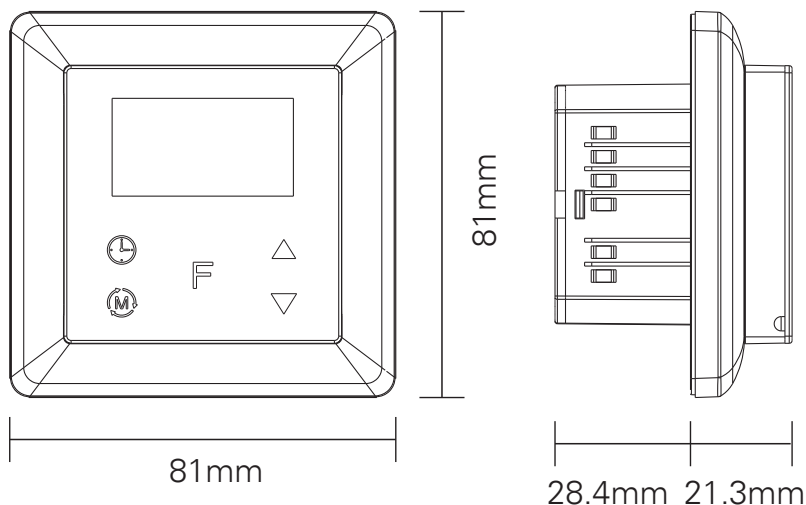

Technical data

ZigBee Frequency	2.4GHz
Operation voltage	220-240V~50/60Hz
Maximum load	16A
Power consumption	<2W
Ambient temperature	0°C to 40°C (during operation)
Temperature range	0°C to 40°C
Hysteresis	0.5°C to 2°C (default 0.5°C)
Floor sensor	NTC R25=10K±1%@25°C, B25/50=3950K±1%, (3m included)
Floor sensors supported	NTC R25=10K±1%@25°C, B25/50=3950K±1% (factory setting) NTC R25=12K±1%@25°C, B25/50=3950K±1% NTC R25=15K±1%@25°C, B25/50=3950K±1% NTC R25=50K±1%@25°C, B25/50=3950K±1% NTC R25=100K±1%@25°C, B25/50=3950K±1%
Control modes	1. Away 2. Auto 3. Manual 4. Drying 5. Off
Control types	Room sensor (factory default) Floor sensor Room + floor sensor This parameter can also be configured through advance config parameter 10
IP rating	IP21
Relative humidity	8% to 80%
Standard	EN 60730-1:2016;A1, EN IEC 60730-2-9:2019;A1 EN IEC 61000-3-2:2019, EN 61000-3-3:2013+A1:2019, EN 60730-1:2016+A1:2019, EN 60730-2-19:2019+A1:2019+A2:2020, EN 50663:2017;ETSI EN 301 489-1V2.2.3, ETSI EN301 489-3V2.1.1 ETSI EN300 220-1 v3.1.1., ETSI EN300 220-2 V3.2.1 RED:2014/53/EU
Certificate	ZigBee 3.0, CE, RED

Installation

- a. Installation must be done by a qualified electrician.
- b. Power supply must be turned off during installation.

(1) Wiring diagram

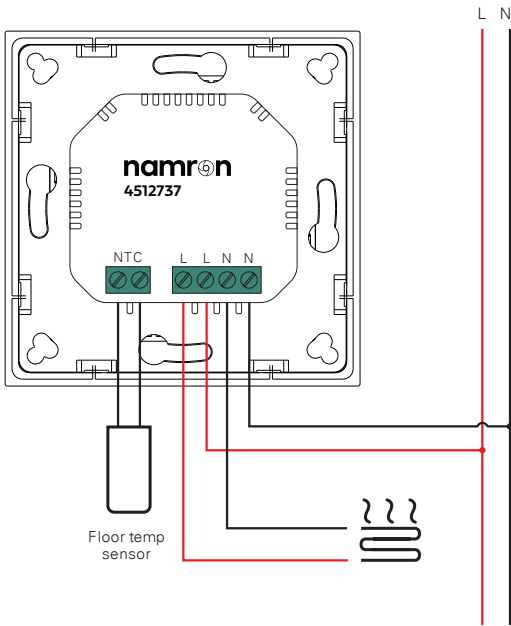

(2) Mounting

- a. Remove the display unit and front cover by using a small screwdriver.
- b. Insert the wires to the correct terminals as presented in the wiring diagram above. Suggested wire-stripping length is 8-10mm.
- c. Fix the thermostat into the connection box by tightening the screws. Make sure that the thermostat is fixed without deformation. Suggested torque is 0.2-0.4Nm (2.0-4.1kgf.cm).

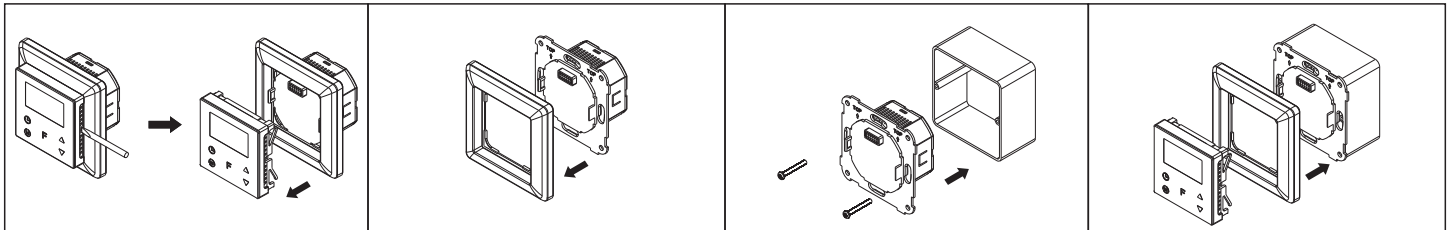

Symbol overview

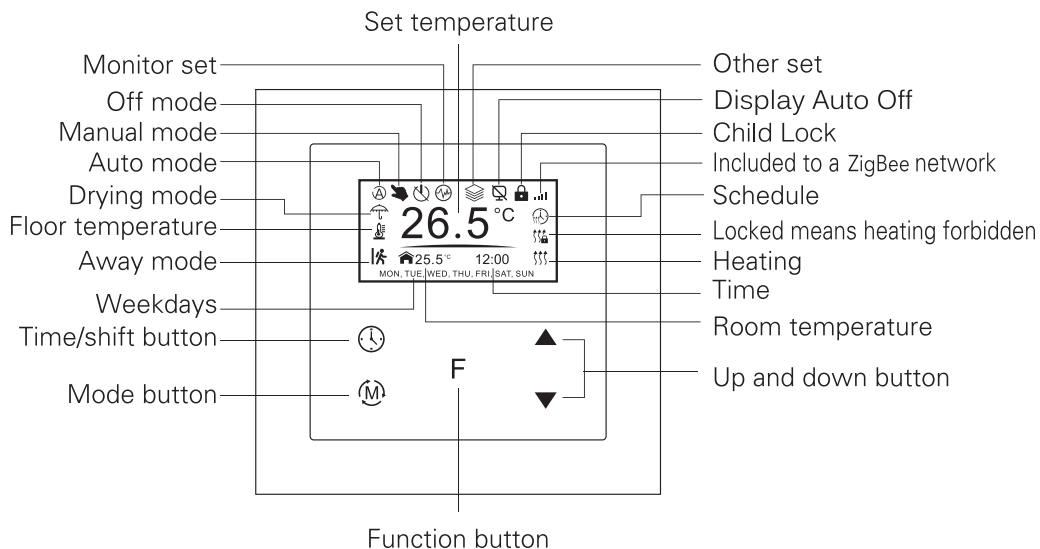

Settings Menu



How to enter settings menu:

1. Under Home Interface, meanwhile the device is at OFF mode (Off icon), press and hold up and down buttons at the same time for over 5 seconds to enter Settings Menu.
2. Short press move up and down button to select a settings item, then short press button F to enter selected item.
3. Settings menu include, Preview menu, Zigbee settings, Schedule, Monitor settings, Time/Date settings, Other settings.

Time Setting

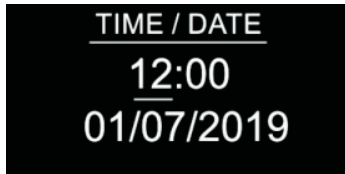
Select TIME/DATE on Home Interface to enter into TIME/DATE SET interface as follow:



Short press button  to select the item would like to modify, then short press move up and move down buttons ▲ ▼ to modify value of selected item, then short press button F to save and quit, short pressing button  only quits without saving.

The device Time Cluster is client, if the bound device supports local time of Time Cluster, the device will acquire local time from the bound device spontaneously under 3 situations: acquire after this device is added to a network, acquire when the device already added to a network and power is reset, acquire every 24 hours .

Standby Interface

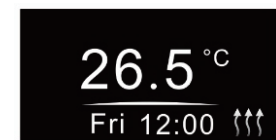

If the device operation mode is set to any other mode except OFF Mode, and there is no operation within 2 minutes, the device will go to this standby interface.



Once the device goes to standby interface, if Display Auto Off function is enabled and there is no operation within 30 seconds, the display will go off automatically.

If the device operation mode is set to OFF Mode, and there is no operation within 2 minutes, the display will go off automatically.

Preview interface

On Home Interface, user can enter into PREVIEW  interface, the interface will display some basic configurations, energy consumption, date, floor temperature etc.

Control Mode

Short press  button on Home Interface to switch operation modes: the icons of Away, Auto, Manual, Drying, Off modes will be displayed alternatively for 3 seconds and last displayed mode will be selected, or just short press F button to select a desired mode when the modes' icon displayed alternatively. Press and hold  button on Home interface for over 3 seconds to select Away mode directly, then Press and hold  button for 3 seconds to quit Away mode.

1. Away Mode Schedule

User can set time to leave home and time to go home according to the requirements of themselves, and set how the device will control the temperature during this period.

1.If away mode has already been activated, the end time for away mode is valid, the device will execute Away Mode Temperature Schedule before the end time.

2.If away mode has already been activated, the values of end time for away mode are set as 0, the device will always execute current set temperature with no time limitation. The device will consider the mode as antifreeze mode, the recommended temperature setting is 4-10 °C, and factory default setting is 6 °C.

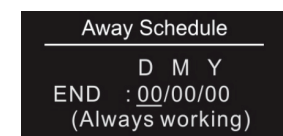

D means date, M means month, Y means year (2019-2099).

Start and end mean away time.

To enter into the setting interface and setting method, please refer to the 1.4 Auto Mode (Energy Save Mode) Schedule.

2. Auto Mode Schedule

When Auto Mode Schedule is valid, the device will control according to the set temperature of the schedule. For instance, if user would like to keep room temperature at 18 degree Celsius during 18:00-23:00 on every Monday, and keep room temperature at 20 degree Celsius after 22:30 on every Monday, then user can set schedule by himself.

Schedule setting method 1: user can enters into  schedule on System Setting Interface, the schedule interface is as follows:



Short press button to select "Auto Schedule", then short press button to enter into Auto Mode Schedule weekly setting interface.

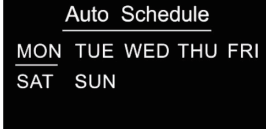

Schedule setting method 2: on System Setting Interface, meanwhile the device is under Auto Mode , short press button to enter into Auto Mode Schedule weekly setting interface quickly:

On Auto Mode Schedule weekly setting interface, use buttons and to enter into schedule setting of a certain week as follows:



On Auto Day Schedule interface, short press button to select the time or temperature that you would like to modify, then short press move up and move down buttons to modify value, then short press button to save and quit, short pressing button only quits without saving.

For each schedule, the latter time should be later than the former time, otherwise saving will fail with the error remind "Time setting error!!!". The default time schedules are as follows:

Monday-Friday	7:30,24C-12:00,20C	Saturday-Sunday	7:30,24C-12:00,20C
	18:00,16C-22:30,18C		18:00,18C-22:30,18C

3. Manual Mode: the device will control the heating system according to current set temperature. The temperature can be set by move up and move down button on the Home interface, or configured by Zigbee gateway.

4. Dry Mode Schedule

For example, in order to quickly dry the water on the floor of the bathroom, the device can be set to quickly heat in a short time to dry the floor. Enter the configuration interface as follows:

Duration: set how long the dry mode lasts, can be configured through the proprietary attribute DryTime (0x1006) of Thermostat Cluster (0x0201), the configurable range is 5-100 minutes.

After Mode: set the mode after the drying mode ends, can be configured through the proprietary attribute ModeAfter-Dry (0x1007) of Thermostat Cluster (0x0201).

Remain: shows the remaining time of the drying mode

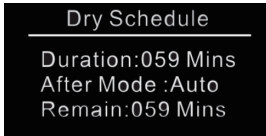

For configuration method and modification, please refer to Automatic Mode (Energy Save Mode) Schedule:

5.Off Mode

This mode means that the device is under idle status.

Window Open Detect (disabled by default)







Once the device is powered on and stable, referring to the room temperature sensor, if the temperature decreases to the threshold of this setting, the window open mark will be enabled, the relay will be forced to turn off to save energy, then the icon will appear.



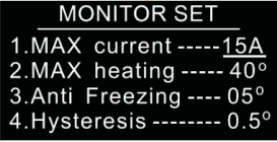





After window open mark is enabled, if the temperature increases to the threshold of this setting in 3 minutes, the window open mark will be disabled.

Once the window open mark is enabled, it will be disabled after 10 minutes, and the device will keep current working mode.

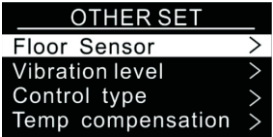
This value can also be configured through the proprietary attribute WindowOpenCheck (0x1009) of Thermostat Cluster (0x0201), 0 means this function is disabled.

Note: this function will work better when the device is installed beside the window or door.

<p>Monitor Set</p>		<p>The function of monitor set is real time monitor of over current, over heat and freezing. On Home Interface, short press  MONITOR SET to enter into monitor set interface as follows: Short press button  to select the item would like to modify, then short press move up and down buttons to modify value of selected item, then short press F button to save and quit, short pressing button  only quits without saving.</p>
<p>Over-current Alarm</p>	<p>16A by default</p>	<p>If current is over the set value, the relay will be forced to off by the device, and the state will be reported to the gateway. The over current alarm function can be disabled, which can be set directly through the device. Or can be configured through the ACAlarmsMask and ACCurrentOverload of Electrical Measurement (0X0B04), for details please refer to the configuration value .</p>
<p>Over-heat Alarm</p>		<p>If room temperature or floor temperature is over the set value, the relay will be forced off by the device, and over heat alarm will be reported to the associated devices, meanwhile the buzzer or vibrator will beep 3 times every 10 seconds. The over heat alarm function can be disabled, which can be set directly through the device. Or can be configured through the attribute AlarmAirTempOverValue (0x2001) of Thermostat Cluster (0x0201), when this value is set as 0, this function is disabled. Over heat alarm interface is as follow: Note: to cancel over current alarm or over heat alarm, just press and hold button  for over 3 seconds or reset power of the device. After cancel manually, the relay will show heating forbidden icon within  120 seconds , but other operations are allowed.</p>
<p>Hysteresis</p>	<p>0.5°C by default</p>	<p>To prevent the undulation of sensor temperature when the sensor temperature is approaching the set temperature, which will cause that the controller may keep switching on/off the relay. Here hysteresis enables the controller to control the relay only when the sensor temperature is a little bit lower than the set temperature, this value can be set. For instance, when hysteresis is set as 0.5 degree, then only when current sensor temperature is 0.5 degree lower than the set temperature, will the controller heat, if the sensor temperature \geq set temperature, the controller will not heat. This value can also be configured through the proprietary attribute Hysteresis (0x100A) of Thermostat Cluster (0x0201). Note: This hysteresis only valid when the control type is single sensor, please refer to the part Control Type.</p>
<p>Key Vibration Set</p>	<p>OFF by default</p>	<p>Set the level of vibration sensor under the buttons or buzzer level. OFF: vibration or buzzer off Low Level, High Level: low vibration or buzzer level, high vibration or buzzer level. This level can also be configured through the proprietary attribute ButtonVibrationLevel (0x1001) of Thermostat Cluster (0x0201).</p>
<p>Display Brightness Set</p>	<p>Mid Level by default</p>	<p>The OLED display brightness when operate the device. High Level, Mid Level, Low Level. This brightness can also be configured through the proprietary attribute OperateDisplayLcdBrightness (0x1000) of Thermostat Cluster (0x0201).</p>

<p>Display Auto Off</p>		<p>On the Home Interface, press and hold both F and ▲ buttons for over 10S, during the process, the icon  will flash slowly, the Display Auto OFF function can be enabled or disabled, when the function is enabled, the icon  will be displayed, otherwise the icon will not be displayed.</p> <p>This Display Auto Off can also be configured through the proprietary attribute 0x100B of Thermostat Cluster (0x0201).</p>
<p>Display Temperature Set</p>	<p>Home Temp by default</p>	<p>This parameter defines which sensor temperature will be displayed on Home page. Floor Temp: floor temperature (external sensor) . Home Temp: indoor air temperature. This status can also be configured through the proprietary attribute TemperatureDisplay (0x1008) of Thermostat Cluster (0x0201).</p>
<p>Other Set</p>		<p>Select  OTHER SET on Home Interface to enter into OTHER SET interface as follow: Short press button  to select the item you would like to modify, then short press move up and down buttons to modify value of selected item, then short press button F to save and quit, short pressing  button only quits without saving.</p>
<p>Temperature Compensation</p>	<p>0 by default</p>	<p>The displayed temperature may has big tolerance caused by the sensor or other factors, so it is necessary to do temp compensation to room sensor and floor sensor. Compensation range is -5 ~ +5°C, stepping is 0.5°C. This value can also be configured through the attribute Local TemperatureCalibration (0x0010) of Thermostat Cluster (0x0201), and through the proprietary attribute FloorSensorCalibration (0x1005) of Thermostat Cluster (0x0201).</p>
<p>Re-power Status</p>	<p>last status by default</p>	<p>Device state after reset power of the device. If set as “last status”, device will go to the status before power failure after power on again. If set as “default”, device will go to default mode after power on again. This status can also be configured through the proprietary attribute PowerUpStatus (0x1004) of Thermostat Cluster (0x0201).</p>
<p>Internal Over Heat Protection</p>		<p>To ensure the safety of the device, if the internal temperature of the device (not displayed on the interface) is over a certain value during heating process, the device will execute a short temporary action to turn off the relay, and the icon  will appear on the interface, after the temperature decreases to a certain value, the device will recover to work.</p>
<p>Child Lock</p>		<p>On the Home Interface, press and hold both F and ▲ buttons for over 10S, the Child Lock can be enabled or disabled, when the Child Lock is enabled, the icon  will appear at the upper right corner, otherwise the icon will not appear. This Child Lock can also be configured through the attribute KeypadLockout (0x0001) of Thermostat Cluster (0x0201).</p>

Zigbee Configuration Introduction

Select  Network Set on Home Interface to enter into Zigbee network management interface as follow:



Adding to a Zigbee Network

Operate your Zigbee gateway to add device, select "Add", then short press button **F**, the device will search network and try to join, "Status" will show "Inclusion...". If there is no response from a gateway, or adding failed, "Status" will show "Fail". If added successfully, "Status" will show "Inclusion OK" and device ID.

Removing from a Zigbee Network

Operate your Zigbee gateway to remove device, Select "Remove", then short press button **F**, the device will send out removing request, "Status" will show "Exclusion...". If there is no response from a gateway, or removing failed, "Status" will show "Fail". If removed successfully, "Status" will show "Exclusion OK" and device ID will be showed as 0. The device will be removed from the network and all parameters will be restored to factory default setting, all bindings will be cleared.

Factory Reset (Reset)

Factory resetting will remove the device from Zigbee network and all parameters will be restored to factory default setting, all bindings will be cleared.

Select "Reset", then short press button **F**, the device will start reset, "Status" will show "Reset...". If exclusion failed, "Status" will show "Fail". If reset successfully, "Status" will show "Reset OK".

Configure Device Operation Mode through Zigbee

Since Zigbee does not have away mode, the attribute Occupancy (occupied or unoccupied) of Thermostat (0x0201) and attribute Occupancy of received OccupancySensing (0x0406) are required to judge whether it is away mode.

1) if the device receives other devices' or the gateway's report: the Bit 0 of the value of attribute Occupancy (0x0000) of OccupancySensing Cluster (0x0406) is 1, which means occupied, then the operation mode of the thermostat, the attribute SystemMode(0x001c)=0x04(heat) of Thermostat (0x0201), meanwhile the value of attribute Occupancy (0x0002) of Thermostat (0x0201) is 0. It means the Away Mode is activated, and the thermostat UI will display.

2) if the gateway send command to modify the attribute SystemMode(0x001c) of Thermostat (0x0201), the thermostat will quit Away Mode. Meanwhile the value of attribute Occupancy (0x0002) of Thermostat (0x0201) is 1.

3) The proprietary attribute 0x2002(Manufacturer Code=0x1224) of the cluster 0x0201 can be modified to configure whether it is away mode or at home.

Note: Away Mode uses attribute UnOccupiedHeatingSetpoint to set temperature.

Other modes uses attribute OccupiedHeatingSetpoint to set temperature.

Zigbee Interface

The thermostat provides 3 zigbee application endpoints:

Endpoint	Profile	Application
0(0x00)	0x0000(ZDP)	ZigBee Device Object (ZDO) – standard management features
1(0x01)	0x0104(HA)	Device ID is 0x0301(Thermostat).
2(0x02)	0x0104(HA)	Device ID is 0x0007(OTA).
242(0xF2)	0xA1E0(GP)	Device ID is 0x0021(GreenPower).

5.1 Application Endpoint #0 –ZigBee Device Object

- Application profile Id 0x0000
- Application device Id 0x0000
- Supports all mandatory clusters

5.2 Application Endpoint #1 –Thermostat

Cluster	supported	Description
0x0000	server	Basic Provides basic information about the device, such as the manufacturer ID, vendor and model name, stack profile, ZCL version, production date, hardware revision etc. Allows a factory reset of attributes, without the device leaving the network.
0x0003	server	Identify Allows to put the endpoint into identify mode. Useful for identifying/locating devices and required for Finding & Binding.
0x0004	server	Groups Allows adding this endpoint to one or more groups. Afterwards the endpoint can be addressed using the group address. This is also a prerequisite for scenes. You may also query group membership and delete group associations.
0x0005	server	Scenes Allows storing one or more scenes per group, where each scene consists of a pre-set on/off state value. You may either store the current values as a scene, or provide scene settings when adding a scene, or delete scenes.
0x0201	server	Thermostat
0x0702	server	Simple Meter
0x0b04	server	Electrical Measurement Measuring power, voltage, current
0x0009	server	Alarm Device related alarm
0x0406	client	Occupancy Sensing
0x000a	Server	Time
0x0204	server	Thermostat User Interface Configuration

5.2.1 Basic -0x0000 (Server)

Attributes supported:

Attribute	Type	Description
0x0000	INT8U, read-only	ZCLVersion 0x03
0x0001	INT8U , read-only	ApplicationVersion This is the firmware version number of the application
0x0002	INT8U , read-only	StackVersion
0x0003	INT8U , read-only	HWVersion Hardware version 1
0x0004	string, read-only	ManufacturerName "NAMRON AS"
0x0005	string, read-only	ModelIdentifier "4512737 & 4512738"
0x0006	string, read-only	DateCode NULL
0x0007	ENUM8, read-only	PowerSource Device power supply, fixed value 0x01 Mains (single phase)

0x0008	ENUM8, read-only	GenericDevice-Class 0XFF
0x0009	ENUM8, read-only	GenericDevice-Type 0XFF
0x000A	octstr read-only	ProductCode 00
0x000B	string, read-only	ProductURL NULL
0x4000	string, read-only	Sw build id 6.9.1.0_r4

Command supported:

Command	Description
0x00	<p>Reset to Factory Defaults Command</p> <p>On receipt of this command, the device resets all the attributes of all its clusters to their factory defaults. Note that networking functionality, bindings, groups, or other persistent data are not affected by this command.</p>

5.2.2 Scenes 0x0005 (Server)

Attributes supported:

Attribute	Type	Description
0x0000	int8u, read-only	SceneCount Holds the total number of scenes (across all groups) currently stored on the device.
0x0001	int8u, read-only	CurrentScene If the SceneValid attribute is true, this attribute, together with the CurrentGroup attribute, indicates the currently active scene.
0x0002	int16u, read-only	CurrentGroup If the SceneValid attribute is true, this attribute, together with the CurrentScene attribute, indicates the currently active scene.
0x0003	bool, read-only	SceneValid If true, the scene identified by CurrentGroup and CurrentScene is currently active, i.e. all device attribute values match the values in the scene field set.
0x0004	bitmap8, read-only	NameSupport

Command supported:

Command	Description
0x00	<p>Add Scene</p> <p>Adds a scene with or without a scene field set</p>
0x01	<p>View Scene</p> <p>Returns the scene field set, name and transition times for a scene.</p>
0x02	<p>Remove Scene</p> <p>Removes a scene from the scene table.</p>
0x03	<p>Remove All Scenes</p> <p>Removes all scenes that belong to a particular group.</p>

0x04	Store Scene Stores the device's current state as a scene or updates a previously stored scene accordingly
0x05	Recall Scene Reverts the device's current state using the values from the previously stored field set.

5.2.3 Groups-0x0004 (Server)

Attributes supported:

Attribute	Type	Description
0x0000	bitmap8, read-only	NameSupport 0, not supported

Command supported:

Command	Description
0x00	Add Group Adds the endpoint to a group.
0x01	View Group Determines whether the device belongs to a group and returns the group name, if supported
0x03	Remove Group Removes this endpoint from the specified group. Also removes all scenes that refer to this group.
0x04	Remove All Groups Removes this endpoint from all groups. Also removes all scenes that refer to any of the existing groups.
0x05	Add Group if Identifying Adds this endpoint to the group, if the endpoint is identifying.

5.2.4 Thermostat-0x0201(Server)

Attributes supported:

Attribute	Type	Description
0x0000	int16S , read-only	reportable LocalTemperature Attribute This is room temperature, the maximum resolution this format allows is 0.01 °C.
0x0001	int16S , read-only	reportable OutdoorTemperature This is floor temperature, the maximum resolution this format allows is 0.01 °C.
0x0002	bitmap8 , read-only	Occupancy When this flag is set as 1, it means occupied, OccupiedHeatingSetpoint will be used, otherwise UnoccupiedHeatingSetpoint will be used.
0x0010	Int8S , reportable	LocalTemperatureCalibration Room temperature calibration, range is -30-30, the maximum resolution this format allows 0.1°C. Default value: 0
0x0011	int16S , reportable	OccupiedCoolingSetpoint This system is not invalid.
0x0012	int16S , reportable	OccupiedHeatingSetpoint Range is 0-4000,the maximum resolution this format allows is 0.01 °C. Default is 0xbb8(30.00°C)
0x0014	int16S , reportable	UnoccupiedHeatingSetpoint Range is 0-4000,the maximum resolution this format allows is 0.01 °C. Default is 0x258(6.00°C)

0x001B	Enum8, reportable	ControlSequenceOfOperation Set device supported operation type, here only supports Heating Only(0x02)
0x0029	Map16, read-only, reportable	HVAC relay state/ ThermostatRunningState Indicates the relay on/off status, here only supports bit0(Heat State)

Proprietary Attributes:

Attribute	Type	Manufacturer code	Description
0x1000	ENUM8, reportable	0x1224	OperateDisplayLcdBrightnesss OLED brightness when operate the buttons: Value=0 : Low Level Value=1 : Mid Level(default) Value=2 : High Level
0x1001	ENUM8 reportable	0x1224	ButtonVibrationLevel Key beep volume & vibration level: Value=0 : off(default) Value=1 : Low Level Value=2 : High Level
0x1002	ENUM8 reportable	0x1224	FloorSenserType Select external (Floor) sensor type: Value=5 : NTC 12K/25 Value=4 : NTC 100K/25 Value=3 : NTC 50K/25 Value=2 : NTC 15K/25 Value=1 : NTC 10K/25 (Default)
0x1003	ENUM8 reportable	0x1224	ControlType The referring sensor for heat control: Value=0 : Room sensor(Default) Value=1 : floor sensor Value=2 : Room+floor sensor
0x1004	ENUM8 reportable	0x1224	PowerUpStatus The mode after reset power of the device: Value=0 : default mode Value=1 : last status before power off (Default)
0x1005	INT8S, reportable	0x1224	FloorSenserCalibration The temp compensation for the external (floor) sensor, range is -30-30, unit is 0.1°C. default value 0
0x1006	INT8U reportable	0x1224	DryTime The duration of Dry Mode, range is 5-100, unit is min. Default value is 5.
0x1007	ENUM8 reportable	0x1224	ModeAfterDry The mode after Dry Mode: Value=0 : OFF Value=1 : Manual mode Value=2 : Auto mode –schedule (default) Value=3 : Away mode
0x1008	ENUM8 reportable	0x1224	TemperatureDisplay : Value=0 : Room Temp (Default) Value=1 : Floor Temp
0x1009	INT8U reportable	0x1224	WindowOpenCheck The threshold to detect open window, range is 0.3-8, unit is 0.5°C, 0 means disabled, default is 0

0x100A	INT8U reportable	0x1224	Hysterersis Hysterersis setting, range is 5-20, unit is 0.1°C, default value is 5
0x100B	ENUM8 reportable	0x1224	DisplayAutoOffEnable 0, disable Display Auto Off function 1, enable Display Auto Off function
0x2001	INT8U, reportable	0x1224	AlarmAirTempOverValue Room temp alarm threshold, range is 0.20-60, unit is 1°C, 0 means disabled, default is 45
0x2002	ENUM8 reportable	0x1224	Away Mode Set: Value=0: not away (default) Value=1: away

Command supported:

Command	Description
0x0000	Setpoint Raise/Lower Increase or decrease the set temperature according to current mode, unit is 0.1°C

5.2.5 Simple Meter-0x0702 (Server)

Attributes supported:

Attribute	Type	Description
0x0000	unsigned48 , read-only, reportable	CurrentSummationDelivered Indicates the current amount of electrical energy delivered to the load.
0x0200	bitmap8 , read-only	Status Flags indicating current device status, always is 0x00
0x0300	enum8 , read-only	UnitOfMeasure The unit of metering data, this is always kWh(0x00)
0x0303	map8 , read-only	SummationFormatting The decimal point on the left and right sides of the data, this is always 0x00
0x0306	bitmap8, read-only	MeteringDeviceType Metering data type, this is always Electric Metering (0x00)

5.2.6 Electrical Measurement-0x0b04(Server)

Attributes supported:

Attribute	Type	Description
0x0000	bitmap32 , read-only	MeasurementType Indicates the physical entities that this devices is able to measure. Supports only bit0: Active measurement (AC)
0x0505	int16U , read-only, reportable	RMSVoltage Single phase valid voltage, unit is V
0x0508	int16U , reportable, read-only	RMSCurrent Single phase valid current, unit is A
0x050B	int16S , reportable read-only	ActivePower Single phase valid power, unit is W
0x0600	int16U, read-only	ACVoltageMultiplier

0x0601	int16U, read-only	ACVoltageDivisor Used together with above attributes, the real displayed voltage = RMSVoltage* ACVoltageMultiplier /ACVoltageDivisor
0x0602	int16U, read-only	ACCurrentMultiplier
0x0603	int16U, read-only	ACCurrentDivisor Used together with above attributes, the real displayed current = RMSCurrent *ACCurrentMultiplier /ACCurrentDivisor
0x0800	int16U,	ACAlarmsMask Specifies which configurable alarms may be generated, only Bit1: Current Overload is set, if set=0, then ACCurrentOverload=0, over current will not be detected
0x0802	int16S , reportable read-only	ACCurrentOverload Alarms when the current is over a certain value, 0, 10-16, unit is A, for the unit please refer to RMSCurrent, ACCurrentMultiplier, ACCurrent Divisor

Proprietary Attributes:

Attribute	Type	Manufacturer code	Description
0x0000	Int8u, reportable	0x1224	OverCurrent Over current value set by the user, range is 0, 10-16, ACCurrentOverload will change spontaneously if this value is modified.

5.2.7 Alarm-0x0009(Server)

Please set a valid value for ACAlarmsMask of Electrical Measurement.

The Alarm Server cluster can generate the following commands

CmdID	Description
0x00	Alarm:

The alarm code of Electrical Measurement is 0,

Proprietary command, **Manufacturer code=0x1224**

CmdID	Description
0x00	Room air temperature over heat, not alarm code

5.2.8 Time-0x000A(server)

The Time cluster is a general cluster for time it is based on a UTC time in seconds since 0 hrs 0 mins 0 sec on 1st January 2000. Refer to [Z2] for ZigBee specification of the time cluster.

The metering device will use this clusters as a client – provided that a suitable Time Server is available on the network (most likely on the Gateway/concentrator)

If the device has bound TIME cluster, then the device will acquire the value of Local Time (0x0007) spontaneously.

5.2.9 OccupancySensing-0x0406(client)

The attributes that can be received:

Attribute	Type	Description
0x0000	bitmap8 ,	Occupancy Bit 0 specifies the sensed occupancy as follows: 1 = occupied, 0 = unoccupied. This flag bit will affect the Occupancy attribute of HVAC cluster, and the operation mode.

5.2.10 Thermostat User Interface Configuration-0x0204(Server)

Attributes supported:

Attribute	Type	Description
0x0000	Enum8, reportable	TemperatureDisplayMode 0x00 Temperature in , only support
0x0001	Enum8, reportable	KeypadLockout 0x00 No Lockout 0x01 - 0x05 lockout

5.3 Application Endpoint #2-OTA

Cluster	supported	Description
0x0000	server	Basic
0x0003	server	Identify
0x0019	Client	OTA Upgrade Pull-oriented firmware upgrade. Searches the network for mating servers and allows the server to control all stages of the upgrade process, including which image to download, when to download, at what rate and when to install the downloaded image.

Ota complies to standard Zigbee protocol.

namron

the smarter choice

Namron AS
Nedre kalbakkvei 88B
1081 Oslo
Norway
post@namron.com