

NAMRON TERMOSTAT TOUCH Z-WAVE 16A

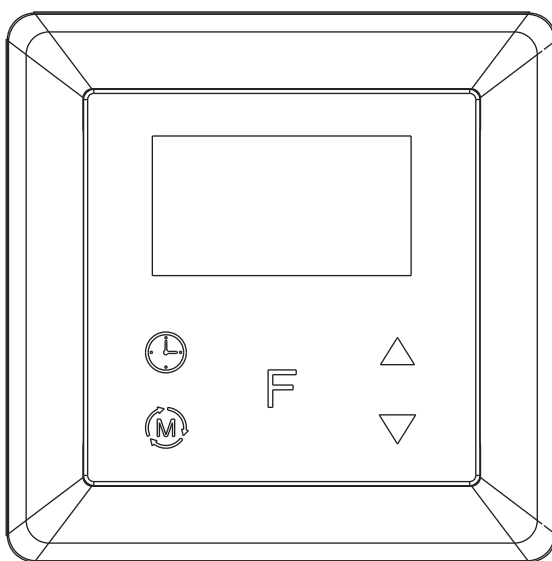

INSTRUCTION MANUAL

Namron termostat touch Z-Wave 16A

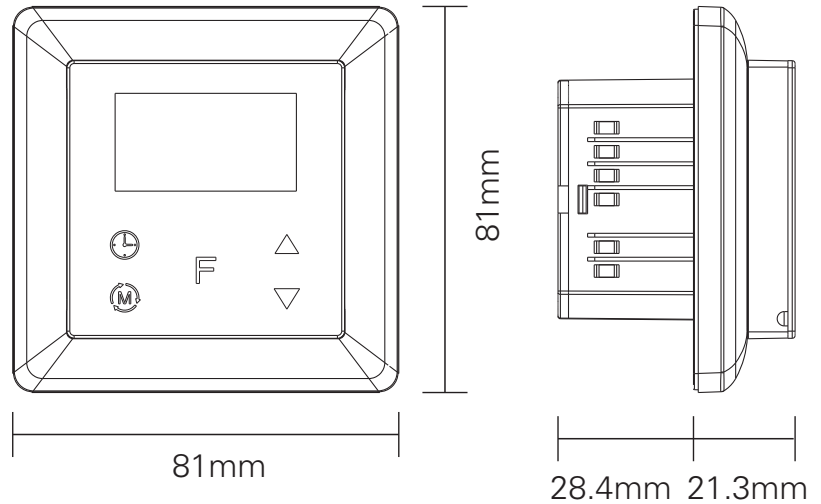

Technical data

Z-Wave frequency	868.42MHz (EU)
Operation voltage	220-240V, 50/60Hz
Maximum load	16A
Power consumption	<2W
Ambient temperature	0°C to 40°C (during operation)
Temperature range	0°C to 40°C
Hysteresis	0.5°C to 2°C (default 0.5°C)
Floor sensor	NTC R25=10K±1%@25°C, B25/50=3950K±1%, (3m included)
Floor sensors supported	NTC R25=10K±1%@25°C, B25/50=3950K±1% (factory setting) NTC R25=15K±1%@25°C, B25/50=3950K±1% NTC R25=50K±1%@25°C, B25/50=3950K±1% NTC R25=100K±1%@25°C, B25/50=3950K±1%
Control modes	1. Away 2. Auto 3. Manual 4. Drying 5. Off
Control types	Room sensor (factory default) Floor sensor Room + floor sensor This parameter can also be configured through advance config parameter 10
IP rating	IP21
Relative humidity	8% to 80%
Standard	EN 60730-1:2016;A1, EN IEC 60730-2-9:2019;A1 EN IEC 61000-3-2:2019, EN 61000-3-3:2013+A1:2019, EN 60730-1:2016+A1:2019, EN 60730-2-19:2019+A1:2019+A2:2020, EN 50663:2017;ETSI EN 301 489-1V2.2.3, ETSI EN301 489-3V2.1.1 ETSI EN300 220-1 v3.1.1., ETSI EN300 220-2 V3.2.1 RED:2014/53/EU
Certificate	Z-Wave plus, CE, RED

Installation

- a. Installation must be done by a qualified electrician.
- b. Power supply must be turned off during installation.

(1) Wiring diagram

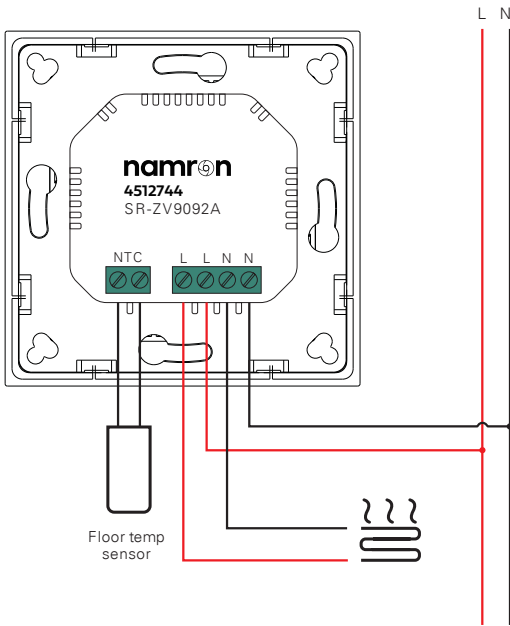

(2) Mounting

- a. Remove the display unit and front cover by using a small screwdriver.
- b. Insert the wires to the correct terminals as presented in the wiring diagram above. Suggested wire-stripping length is 8-10mm.
- c. Fix the thermostat into the connection box by tightening the screws. Make sure that the thermostat is fixed without deformation. Suggested torque is 0.2-0.4Nm (2.0-4.1kgf.cm).

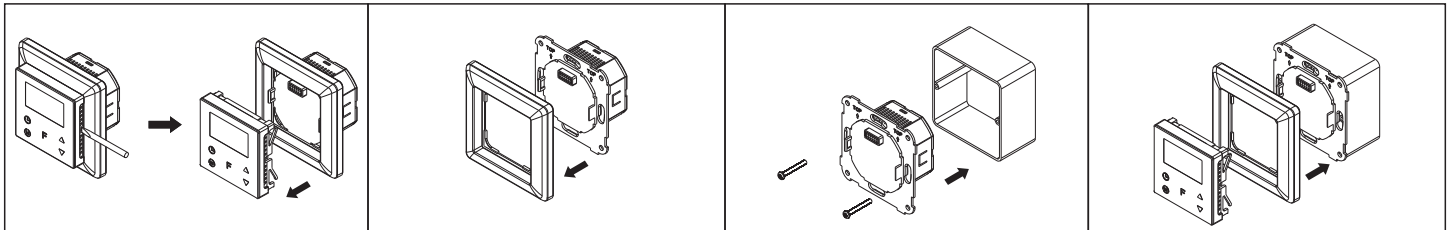

Symbol overview

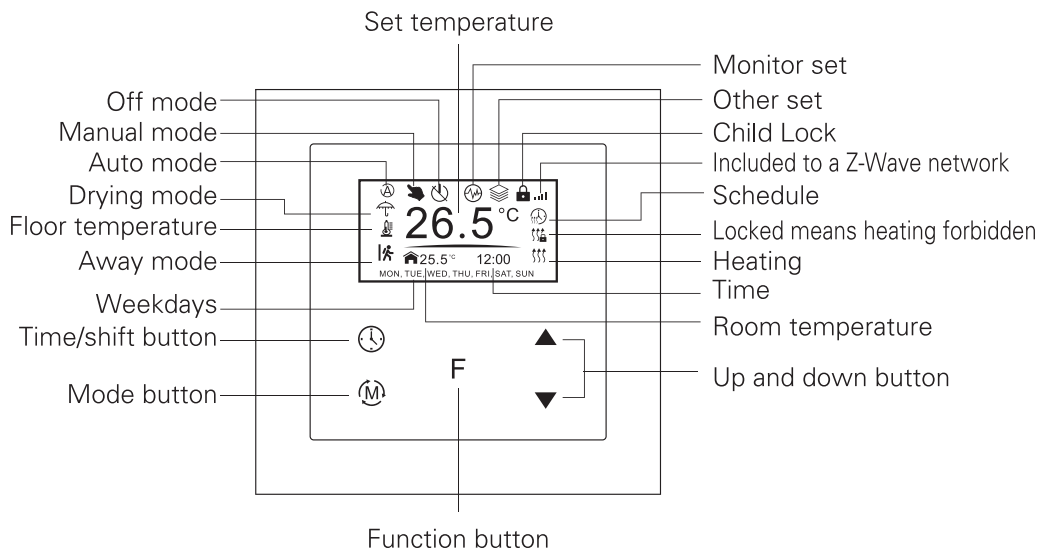

Settings Menu

Select TIME/DATE on Home Interface to enter into TIME/DATE SET interface as follow:



Enter settings menu (needs to be added)

1. Under Home Interface, meanwhile the device is at OFF mode (Off icon), press and hold up and down buttons at the same time for over 5 seconds to enter Settings Menu.
2. Short press move up and down button to select a settings item, then short press button F to enter selected item.
3. Settings menu include, Preview menu, Z-Wave settings, Schedule, Monitor settings, Time/Date settings, Other settings

Time Setting

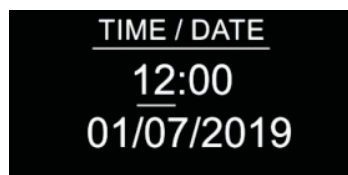
Select TIME/DATE on Home Interface to enter into TIME/DATE SET interface as follow:





Short press button  to select the item you would like to modify, then short press up and down buttons to modify value of selected item, then short press button F to save and quit, short pressing button  only quits without saving.

2. Preview interface

On Home Interface, user can enter into PREVIEW  interface, the interface will display some basic configurations, energy consumption, date, floor temperature etc.

Control Mode

Short press  button on Home Interface to switch operation modes: the icons of Away, Auto, Manual, Drying, Off modes will be displayed alternatively for 3 seconds and last displayed mode will be selected, or just short press F button to select a desired mode when the modes' icon displayed alternatively. Press and hold  button on Home interface for over 3 seconds to select Away mode directly, then Press and hold  button for 3 seconds to quit Away mode.

1. Away Mode: the device will control the heating system according to the set temperature within the set period.

User can set time to leave home and time to go home according to the requirements of themselves, and set how the device will control the temperature during this period.

1.1. If away mode has already been activated, the end time for away mode is valid, the device will execute Away Mode Temperature Schedule before the end time.

1.2. If away mode has already been activated, the values of end time for away mode are set as 0, the device will always execute current set temperature with no time limitation. The device will consider the mode as anti-freeze mode, the recommended temperature setting is 4-10°C.

2. Auto Mode: the device will control the heating system according to the configured time schedule or Z-Wave protocol Energy_Save_Heating Setpoint.

2.1. When configuration parameter 8 value set as 1, the device will control the temperature of energy save mode according to the temperature set by Command Class Energy_Save_Heating Setpoint or set by using the move up and down buttons, following mentioned schedule will be invalid.

2.2. When configuration parameter 8 value set as 0, the temperature set by Command Class Energy_Save_Heating Setpoint and set by using the move up and move down buttons will both be invalid, Energy Save Mode will control temperature according to following user schedule.



For instance, if user would like to keep room temperature at 18C during 18:00-23:00 on every Monday, and keep room temperature at 20C after 22:30 on every Monday, then user can set schedule by himself.

Schedule setting method 1: user can enter into  schedule on Z-Wave Set Interface, the schedule interface is as follows:



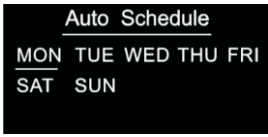

Short press button  to select "Auto Schedule", then short press button **F** Schedule weekly setting interface.

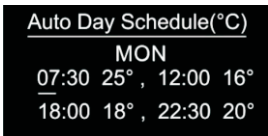

Schedule setting method 2: on Home Interface, meanwhile the device is under Auto Mode , short press button  to enter into Auto Mode Schedule weekly setting interface quickly:

On Auto Mode Schedule weekly setting interface, use buttons  and **F** to enter into schedule setting of a certain week as follows:



On Auto Day Schedule interface, short press button  to select the time or temperature that you would like to modify, then short press move up and down buttons to modify value, then short press button **F** to save and quit, short pressing button  only quits without saving.

For each schedule, the latter time should be later than the former time, otherwise saving will fail with the error remind "Time setting error!!!". The default time schedules are as follows:

Monday-Friday	7:30,24C-12:00,20C	Saturday-Sunday	7:30,24C-12:00,20C
	18:00,16C-22:30,18C		18:00,18C-22:30,18C

3. Manual Mode: the device will control the heating system according to current set temperature. The temperature can be set by move up and move down button on the Home interface, or configured by Z-Wave gateway.

4. Drying Mode: The device will judge the set temperature for heating within a short period of time.

I.e.: in order to dry the water in the bathroom in a short time, the device could be set to quickly heat to dry the floor. Enter the configuration interface as follow:

Duration: set how long the dry mode should lasts





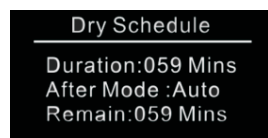

After Mode: set the mode after the drying mode ends



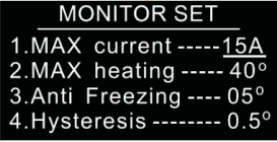



Remain: shows the remaining time of the drying mode

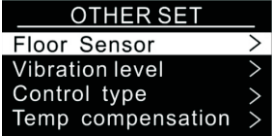

For configuration method and modification, please refer to Automatic Mode (Energy Save Mode) Schedule:

5. Off Mode: this mode only enables the device to turn on the heating system when anti freezing mode is enabled and the device meets all required conditions, otherwise the device will not work, meanwhile the standby interface will only show room temperature.

<p>Monitor Set</p>		<p>The function of monitor set is real time monitor of over current, over heat and freezing. On Home Interface, short press  MONITOR SET to enter into monitor set interface as follows: Short press button  to select the item would like to modify, then short press move up and down buttons to modify value of selected item, then short press F button to save and quit, short pressing button  only quits without saving.</p>
<p>Over-current Alarm</p>		<p>If current is over the set value, the relay will be forced off by the device, and the state will be reported to the gateway. The over current alarm function can be disabled, which can be set directly through the device. Or can be configured through Advance Config parameter 2 by setting the value as 0 to disable the function, please refer to the part "Advance Config".</p>
<p>Over-heat Alarm</p>		<p>If room temperature or floor temperature is over the set value, the relay will be forced off by the device, and over heat alarm will be reported to the associated devices, meanwhile the buzzer or vibrator will beep 3 times every 10 seconds. The over heat alarm function can be disabled, which can be set directly through the device. Or can be configured through Advance Config parameter 6 by setting the value as 0 to disable the function, please refer to the part "Advance Config". Over heat alarm interface is as follow: Note: to cancel over current alarm or over heat alarm, just press and hold button  for over 3 seconds or reset power of the device. After cancel manually, the relay will show heating forbidden icon within  120 seconds , but other operations are allowed.</p>
<p>Hysteresis</p>		<p>To prevent the undulation of sensor temperature when the sensor temperature is approaching the set temperature, which will cause that the controller may keep switching on/off the relay. Here hysteresis enables the controller to control the relay only when the sensor temperature is a bit lower than the set temperature, this value can be set. This hysteresis only valid when the control type is single sensor, please refer to the part Control Type. For instance, when hysteresis is set as 0.5 degree, then only when current sensor temperature is 0.5 degree lower than the set temperature, will the controller heat, if the sensor temperature \geq set temperature, the controller will not heat.</p>
<p>Key Vibration Set</p>		<p>Set the level of vibration sensor under the buttons or buzzer level. OFF: vibration or buzzer off Low Level, High Level: low vibration or buzzer level, high vibration or buzzer level. The level can also be configured through Advance Config parameter 03.</p>
<p>Display Brightness Set</p>		<p>The OLED display brightness when operate the device. High Level, Mid Level, Low Level. This parameter can also be configured through Advance Config parameter [22].</p>
<p>Display Temperature Set</p>		<p>This parameter defines which sensor temperature will be displayed on Home page. Floor Temp: floor temperature (external sensor) . Home Temp: indoor air temperature. This parameter can also be configured through Advance Config parameter [23].</p>

<p>Other Set</p>		<p>Select  OTHER SET on Home Interface to enter into OTHER SET interface as follow:</p> <p>Short press button  to select the item you would like to modify, then short press move up and down buttons to modify value of selected item, then short press button F to save and quit, short pressing  button only quits without saving.</p>
<p>Temperature Compensation</p>		<p>The displayed temperature may has big tolerance caused by the sensor or other factors, so it is necessary to do temp compensation to room sensor and floor sensor. Compensation range is -5 ~ +5°C, stepping is 0.5°C. This parameter can a lso be configured through Advance Config parameter [11] and [12] .</p>
<p>Re-power Status</p>		<p>Device state after reset power of the device.</p> <p>If set as "last status", device will go to the status before power failure after power on again.</p> <p>If set as "default", device will go to default mode after power on again.</p> <p>This parameter can also be configured through Advance Config parameter [4].</p>
<p>Internal Over Heat Protection</p>		<p>To ensure the safety of the device, if the internal temperature of the device (not displayed on the interface) is over a certain value during heating process, the device will execute a short temporary action to turn off the relay, and the icon  will appear on the interface, after the temperature decreases to a certain value, the device will recover to work.</p>
<p>Child Lock</p>		<p>Press and hold F and  buttons for over 10S,then the child lock can be activated or cancelled. When child lock is activated, then icon  will appear on the display.</p>

Z-Wave Set Introduction

1.Z-Wave Network Management

Select  ZWAVE INFO on Home Interface to enter into Z-Wave network management interface as follow:

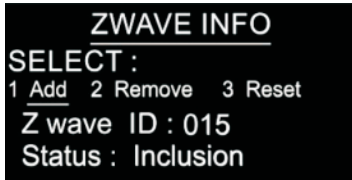

Adding to a Z -Wave Network (Inclusion)

Method 1: Select "Add", then short press button , the device will send out inclusion request, "Status" will show "Inclusion...". If there is no response from a gateway within 30 seconds, or inclusion failed, "Status" will show "Fail". If included successfully, "Status" will show "Inclusion OK" and device ID.

Method 2: Operate the gateway into inclusion mode, make sure the device is already removed from previous network, reset power of the device, the device will be included to the gateway automatically.

Smart Start

If the user's gateway also supports smartstart, add the device by scanning the QR code, Smartstart allows users to quickly add devices to the gateway by scanning the device's QR code.

After scanning to add the device, reset power of the device or waiting for a while, the device will be added to the gateway automatically. Please find the QR code on the casing of the device.

Removing from a Z-Wave Network (Exclusion)

Select "Remove", then short press button **F** , the device will send out exclusion request, "Status" will show "Exclusion...". If there is no response from a gateway within 30 seconds, or exclusion failed, "Status" will show "Fail". If excluded successfully, "Status" will show "Exclusion OK" and device ID will be showed as 0.

Factory Reset (Reset)

Factory resetting will reset all Advance Config parameters to default value, and the device will be removed from the Z-Wave network.

Select "Reset", then short press button **F** , the device will start reset, "Status" will show "Reset...". If there is no response from a gateway within 6 seconds, or exclusion failed, "Status" will show "Fail". If reset successfully, "Status" will show "Reset OK".

Note 1: if the device is excluded or reset successfully, the Auto Mode Schedule will be reset to default value.

Note 2: the sent frame of inclusion and exclusion is INFO frame.

2.Basic set command class

Set the device operation mode as Comfort Mode (Manual Mode) by sending command class basic set = 0XFF. Set the device operation mode as OFF mode by sending command class basic set = 0x00

Z-Wave Technical Specifications

1.Supported Notification Report and Sensor Type

Notification Type	Triggering Event	Description
POWER_MANAGEMENT	POWER_MANAGEMENT_OVERCURRENT_DETECTED	Over Current Alarm
Heat Alarm	Overheat detected	Over Heat Alarm

SENSOR MULTILEVEL Type support	Scale
Air temperature	Celsius (°C)

2. Technical Specifications

Item	Definition
SDK	6.82.00
Explorer Frame Support	Yes

Device Type	Thermostat(HVAC)
Generic Device Class	GENERIC_TYPE_THERMOSTAT
Specific Device Class	SPECIFIC_TYPE_THERMOSTAT_HEATING
Role Type	Always On Slave (AOS))
Routing	Yes

Thermostat Related Specifications

Command	Support
ThermostatMode	ThermostatMode_OFF(off) ThermostatMode_HEAT(UI displays Manual) ThermostatMode_DRY ThermostatMode_EnergyHeat(UI displays Auto) ThermostatMode_Away(UI displays Away)
ThermostatSetPoint	ThermostatSetPointType_Heating(set manual temperature) ThermostatSetPointType_Energy_Save_Heating(set auto temperature) ThermostatSetPointType_DRY ThermostatSetPointType_Away_Heating(set away temperature)

3. Supported Command Class

Root Device

Support Command class		Support S2/s0
COMMAND_CLASS_ZWAVEPLUS_INFO	V2	
COMMAND_CLASS_SECURITY	V1	
COMMAND_CLASS_SECURITY_2	V1	
COMMAND_CLASS_TRANSPORT_SERVICE	V2	
COMMAND_CLASS_SUPERVISION	V1	
COMMAND_CLASS_THERMOSTAT_MODE	V3	YES
COMMAND_CLASS_THERMOSTAT_OPERATING_STATE	V1	YES
COMMAND_CLASS_THERMOSTAT_SETPOINT	V2	YES
COMMAND_CLASS_ASSOCIATION	V2	YES
COMMAND_CLASS_MULTI_CHANNEL_ASSOCIATION	V3	YES
COMMAND_CLASS_ASSOCIATION_GRP_INFO	V1	YES
COMMAND_CLASS_VERSION	V3	YES
COMMAND_CLASS_MANUFACTURER_SPECIFIC	V2	YES
COMMAND_CLASS_DEVICE_RESET_LOCALLY	V1	YES
COMMAND_CLASS_POWERLEVEL	V1	YES
COMMAND_CLASS_TIME_PARAMETERS	V1	YES
COMMAND_CLASS_CONFIGURATION	V1	YES
COMMAND_CLASS_NOTIFICATION	V8	YES
COMMAND_CLASS_METER	V3	YES
COMMAND_CLASS_MULTI_CHANNEL	V4	YES
COMMAND_CLASS_FIRMWARE_UPDATE_MD	V4	YES

Controlled command class		Support S2/s0
COMMAND_CLASS_THERMOSTAT_MODE	V3	YES
COMMAND_CLASS_THERMOSTAT_SETPOINT	V2	YES

Note: the EndPoint01 mirrors equivalent effect root endpoint.

EndPoint1 command list:

Support command class		Support S2/s0
COMMAND_CLASS_ZWAVEPLUS_INFO	V2	
COMMAND_CLASS_SECURITY	V1	
COMMAND_CLASS_SECURITY_2	V1	
COMMAND_CLASS_SUPERVISION	V1	
COMMAND_CLASS_SENSOR_MULTILEVEL	V5	YES
COMMAND_CLASS_ASSOCIATION	V2	YES
COMMAND_CLASS_MULTI_CHANNEL_ASSOCIATION	V3	YES
COMMAND_CLASS_ASSOCIATION_GRP_INFO	V1	YES
COMMAND_CLASS_THERMOSTAT_MODE	V3	YES
COMMAND_CLASS_THERMOSTAT_OPERATING_STATE	V1	YES
COMMAND_CLASS_THERMOSTAT_SETPOINT	V2	YES

EndPoint2 (floor temperature sensor) command list:

Support command class		Support S2/S0
COMMAND_CLASS_ZWAVEPLUS_INFO	V2	
COMMAND_CLASS_SECURITY	V1	
COMMAND_CLASS_SECURITY_2	V1	
COMMAND_CLASS_SUPERVISION	V1	
COMMAND_CLASS_SENSOR_MULTILEVEL	V5	YES
COMMAND_CLASS_ASSOCIATION	V2	YES
COMMAND_CLASS_MULTI_CHANNEL_ASSOCIATION	V3	YES
COMMAND_CLASS_ASSOCIATION_GRP_INFO	V1	YES

5.Association

Root device

Group ID	NAME	Profile	Max nodes	Description
1	Lifeline	AGI_LIFE_LINE (0x0001)	5	1.Send Command Class DEVICE_RESET_LOCALLY_NOTIFICATION to associated devices of this group when factory reset the device. 2.Send Command Class THERMOSTAT_SETPOINT_REPORT, THERMOSTAT_MODE_REPORT, THERMOSTAT_OPERATING_STATE_REPORT to associated devices of this group When operation mode and temperature change. 3.Send Command Class NOTIFICATION_REPORT to associated devices of this group when over current, over heat detected 4.Send Command Class METER_REPORT to associated devices of this group to report metering parameters.
2	Heat Set	AGI_CONTROL_ KEY01 (0x2001)	5	Transfer Command Class THERMOSTAT_SETPOINT_SET THERMOSTAT_MODE_SET to control other temperature control devices when operation changes

EndPoint01 :

Group ID	NAME	Profile	Max nodes	Description
1	Lifeline	AGI_LIFE_LINE (0x0001)	0	Lifeline(0x0001)

Note: the EndPoint01 has equivalent effect of root function.

EndPoint02

Group ID	NAME	Profile	Max nodes	Description
1	Lifeline	AGI_LIFE_LINE (0x0001)	0	Lifeline(0x0001)

6.Advance Config Parameters

Parameter	Size	Description	Default Value	Parent Menu
0x02(2)	1	Over current detection max. value, unit is A. When detected current is over this value, the device will turn off the relay and send NOTIFICATION CC. 0, disable over current detection 5-16, over current detection max. value	16	Monitor Set
0x03(03)	1	Vibration level and buzzer level triggered by pressing buttons 0, disable vibration and buzzer 1, Low Level 2, High Level	1	Other Set
0x04(4)	1	Whether to recover to settings before power failure or power reset 0, use default settings 1, recover to settings before power failure or power reset	1	Other Set
0x06(6)	1	High temperature detection max. value, unit is $^{\circ}\text{C}$, when either temperature sensor is higher than this value, the device will turn off the relay and send NOTIFICATION CC. 0, disable this function 20-60, the high temperature value	45	Monitor Set
0x07(7)	1	Temperature control hysteresis value setting, setting range $0.5^{\circ}\text{C} - 2^{\circ}\text{C}$ 5-20, unit is 0.1°C	5	Monitor Set
0x08(8)	1	Auto mode (Energy save mode) temperature schedule 0, use schedule set by user 1, use Energy_Save_Heating temperature set by THERMOSTAT_SETPOINT_SET	0	None
0x09(9)	1	Select floor temperature sensor type 1, NTC/10K B(25/50 $^{\circ}\text{C}$)=3950 2, NTC/15K B(25/50 $^{\circ}\text{C}$)=3950 3, NTC/50K B(25/50 $^{\circ}\text{C}$)=3950 4, NTC/100K B(25/50 $^{\circ}\text{C}$)=3950	1	Other Set
0x0A(10)	1	Temperature control reference selection 1, room sensor 2, floor sensor 3, room+floor sensor	1	Other Set
0x0B(11)	1	ROOM SENSOR temperature compensation setting -10~10, unit is 0.5°C	0	Other Set
0x0C(12)	1	FLOOR S ENSOR temperature compensation setting -10~10, unit is 0.5°C	0	Other Set
0x0D(13)	1	Set how long the drying mode lasts 5~100, unit is minute	30	Dry Mode Schedule
0x0E(14)	1	Set the mode a fter the drying mode ends 0x00 = OFF 0x01 = Manual mode (comfort mode) 0x02 = Auto mode (energy save mode) 0x03 = Away mode	2	Dry Mode Schedule
0x10(16)	1	When to report temperature relative change threshold value actively, unit is 0.1°C 0, d isab le t o r ep or t 2- 10, rep or t when t he threshold v alue i s 2- 10	2	None

0x11(17)	1	Time interval value for periodic report of temperature, humidity, unit is S 0, disable to report 30~28800, report when time interval value is 30~28800	300 (5mins)	None
0x12(18)	1	When to report power change absolute threshold, unit is W 0, disable to report 1~100, report when absolute threshold is 1~100	5	None
0x13(19)	1	When to report current change absolute threshold, unit is 0.1A 0, disable to report 1~10, report when absolute threshold is 1~10	10	None
0x14(20)	1	When to report voltage change absolute threshold, unit is 1 V 0, disable to report 1~10, report when absolute threshold is 1~10	2	None
0x15(21)	4	Time interval value for periodic active report of Meter 60-2678400 (31 days) , unit is S	600 (10mins)	None
0x16(22)	1	The OLED display brightness when operate the device. 0, low level 1, mid level 2, high level	1	Other Set
0x17(23)	1	This parameter defines which sensor temperature will be displayed on Home page. 0x00: indoor a ir temperature 0x01: external temperature (floor temperature)	0	Other Set
0x18(24)	1	The time zone that the time parameters command adopts is UTC, the time zone need to be set: +12 ~ -12	0	Other Set

